



BX2694

2023-2025 Ford Escape Hybrid (No Plug-In) (Includes Adaptive Cruise Control & Shuttters) Installation Instructions

Attachment Tab Height: 14"

Attachment Tab Width: 21.5"

Serial Number

Please read BOTH these Installation Instructions and the General Information sheet prior to installing or operating this equipment.

1. Blue Ox® towing products and accessories are intended to be installed by Blue Ox® Dealers who are familiar with our products and have the equipment and knowledge necessary to do "fit work". If needed, Blue Ox® Dealers can be found at www.blueox.com or by contacting our Customer Care Department at (402) 385-3051.
2. Many Blue Ox® baseplates are designed to use existing holes and hardware to mount the baseplate to the towed vehicle. Even though bolts are there, do not assume they are adequate for baseplate mounting. Always use the hardware supplied in the hardware kit and existing hardware as specified in the installation instructions.



If the front of your vehicle looks different than this, please contact us at (402)385-3051.

Reference your vehicle owner's manual for manufacturer's towing specifications.

Bolt Torque Specifications

Torque in Foot-Pounds for Inch Bolts

Bolt Size	Grade 5	Grade 8
1/4"	10	14
5/16"	19	29
3/8"	33	47
7/16"	54	78
1/2"	78	119
5/8"	154	230
3/4"	257	380

Bolt Torque Specifications

Torque in Foot-Pounds for Metric Bolts

Bolt Size	Grade 8.8	Grade 10.9
6MM	6	8
8MM	16	22
10MM	31	40
12MM	54	70
14MM	89	117
16MM	161	230
18MM	222	318



WARNING

Failure to read and follow these instructions could result in separation of the towed vehicle from the tow bar, causing property damage, loss of towed vehicle, personal injury or death.

BX2694

2023-2025 Ford Escape Hybrid (No Plug-In) (Includes ACC & Shutters) Installation Instructions

Instruction Notes: The fascia is removed and reinstalled for the baseplate installation. Some drilling and trimming is required.

Place all components that are removed on a flat, sturdy surface. All items will be reinstalled unless otherwise noted after the baseplate is installed.

The dimensional variations between otherwise identical vehicles can be considerable. While the baseplate was designed for easy installation, it may be necessary to tailor the baseplate slightly to compensate for vehicle manufacturer's tolerances.

The BX8848 Tail Light Wiring Kit is recommended for this vehicle.

Note: A charge line from the RV to the car's battery is needed for this vehicle to prevent draining the car battery while towing.

Tail Light Housing Removal Instructions



1. Remove the bolt cover from the tail light housing. Do this on both sides of the vehicle.



2. Remove the five (5) push pins from along the edge of the rear wheel well. Do this on both sides of the vehicle.

BX2694

2023-2025 Ford Escape Hybrid (No Plug-In) (Includes ACC & Shutters) Installation Instructions



3. Pull back the wheel well trim and hold in place with a soft cloth. Remove the one (1) push pin from the rear panel joint. Do this on both sides of the vehicle.



4. Remove the rear panel below the tail light housing. Do this on both sides of the vehicle.

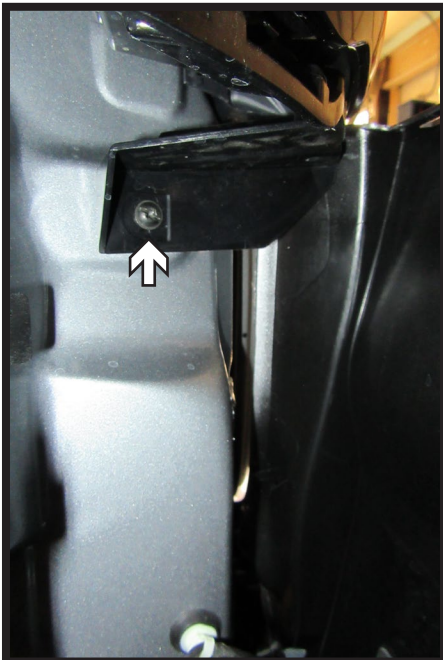

5. Using a T25 Torx, remove the two (2) bolts from the tail light housing. Remove housing and install tail light wiring kit per manufactures instructions. Reinstall tail light housing, rear panel and push pins. Do this on both sides of the vehicle.

BX2694
2023-2025 Ford Escape Hybrid (No Plug-In) (Includes ACC & Shutters)
Installation Instructions

NOTICE

- Handling of some cosmetic parts when installing this product may require the use of protective covers, rags, specialty tools, etc. to prevent damage.
- When using power drills be aware of the dangers of torque and drill bit length.
- When using a reciprocating saw be aware of objects behind the cutting surface.
- Use a good quality paint to spray cut edges of frame to prevent rusting.
- Be sure that **ALL** electrical connections are plugged in and accessories are functioning properly before reinstalling the fascia.
- The baseplate is computer tested to your vehicle's GVWR, exceeding this weight will void the manufacturer's warranty.
- Be sure to use a sufficient amount of Loctite® Red on all bolt threads before tightening. Tighten all bolts according to the torque chart provided unless specified.
- Dealer or installer be certain the user receives these instruction sheets.
- If the baseplate is in an accident, it must be replaced. **DO NOT** use it again! An accident can cause unseen damage and using it again could result in more damage or serious injury. **DO NOT** use the baseplate if it is damaged or missing parts.

BX2694

2023-2025 Ford Escape Hybrid (No Plug-In) (Includes ACC & Shutters) Installation Instructions

Tools Required

Large Vise Grip	3/8" Drill Bit
Flat Screw Driver	1/2" Drill Bit
Torque Wrench	5/8" Drill Bit
Utility Knife	8MM Socket
Pliers	10MM Socket
Level	11MM Socket
Drill	11MM Wrench
Loctite® RED	13MM Socket
T30 Torx	3/4" Socket
T25 Torx	1-1/4" Hole Saw

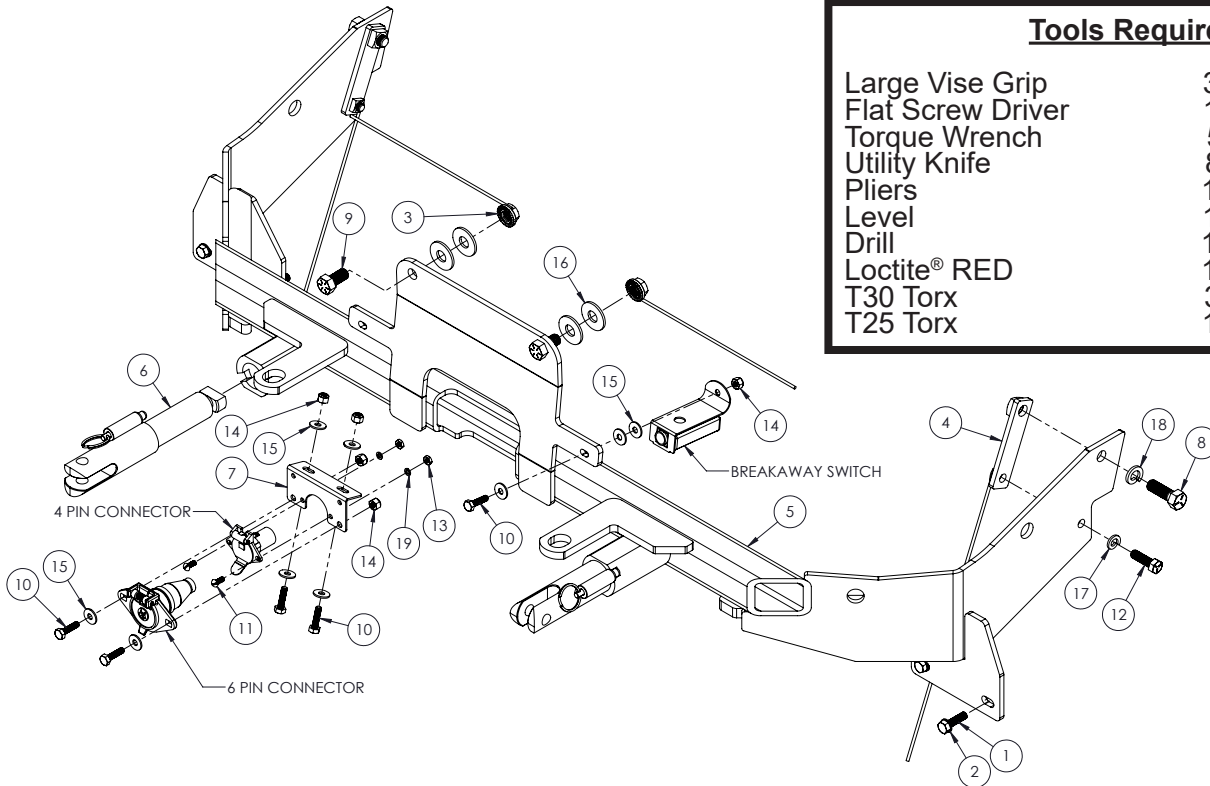

Item No.	Part No.	Description	Qty.
1	Existing	8MM Bolt	4
2	Existing	8MM Washer	4
3	61-4029	1/2"-13 Whiz Nut w/ 10" Wire	2
4	61-8344	Nut Plate, 2 Holes	2
5	61-8639	BX2694 Baseplate	1
6	62-3469	Attachment Tab Assembly with Hole	2
7	101-10930	Electrical Bracket, 105° Bend	1
8	201-0051	1/2"-13 x 1-1/2" Hex Head Bolt, Grade 5, ZP	2
9	201-0060	1/2"-13 x 1" Hex Head Bolt, Grade 5, ZP	2
10	201-0071	1/4"-20 x 1" Hex Bolt, Grade 5, ZP	5
11	201-0192	#10-32 1/2" Round Slotted Head Screw	2
12	201-0368	3/8"-16 x 1-1/4" Hex Head Bolt, Grade 5, ZP	2
13	202-0047	#10-32 Hex Nut	2
14	202-0102	1/4"-20 Hex Nylon Nut, ZP	9
15	203-0001	1/4" Flat Washer, ZP	4
16	203-0005	1/2" Flat Washer, ZP	2
17	203-0010	3/8" Lock Washer, ZP	2
18	203-0012	1/2" Lock Washer, ZP	2
19	203-0054	#10 Lock Washer, ZP	2
20	226-0046(not shown)	Class III Safety Cables	2
21	229-0359(not shown)	3/8" Quicklink, ZP	2
22	290-0437(not shown)	Black Cap Plug Receiver	2

Important:

Use only genuine factory replacement parts on your baseplate. Do **NOT** substitute homemade or non-typical parts. If a bolt is lost or in need of replacement, for your safety and the preservation of your baseplate, be sure to use a replacement bolt of the same grade (In most cases it will be Grade 5, please reference the parts list above). Replacement parts may be ordered through your nearest Blue Ox® Dealer or Distributor. Failing to follow and/or altering these installation instructions in either installation or required equipment will void the manufacturer's warranty. Towing behind a non-motorized vehicle will void the warranty.

2023-2025 Ford Escape Hybrid (No Plug-In) (Includes ACC & Shutters)
Installation Instructions

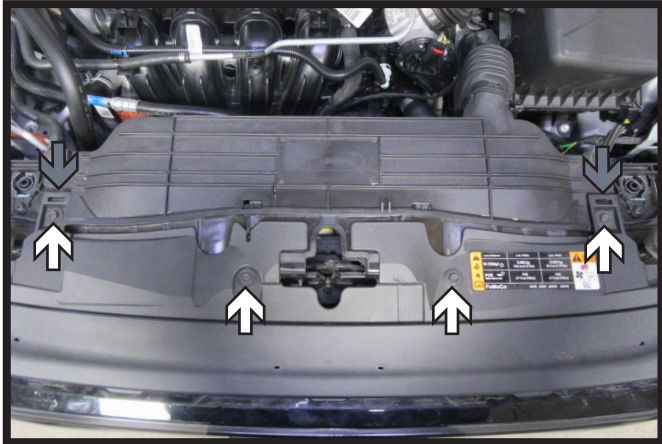

1. Using a 10MM socket, remove the four (4) bolts (white) from the top edge of the fascia. There are two (2) on each side. Then unclip the two (2) push pins (gray), one (1) on each side.



2. Remove the eight (8) push pins from along the edge of the wheel well. Do this on both sides of the vehicle.

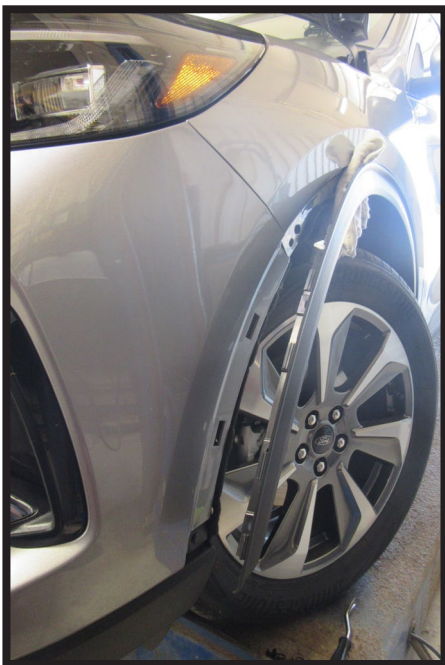

3. Pull back the wheel well trim past the fascia joint and hold in place with a soft cloth. Do this on both sides of the vehicle.



4. Pull back the wheel well liner. Using a 10MM socket, remove the two (2) bolts from the fascia joint. Do this on both sides of the vehicle.

BX2694
2023-2025 Ford Escape Hybrid (No Plug-In) (Includes ACC & Shutters)
Installation Instructions

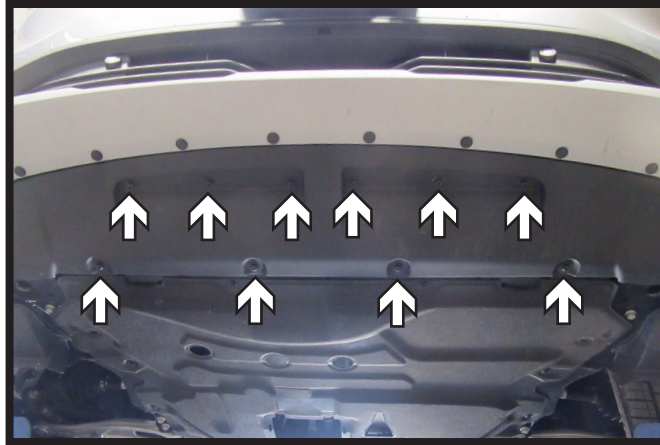

5. Using a T30 Torx, remove the ten (10) bolts from the bottom of the fascia.

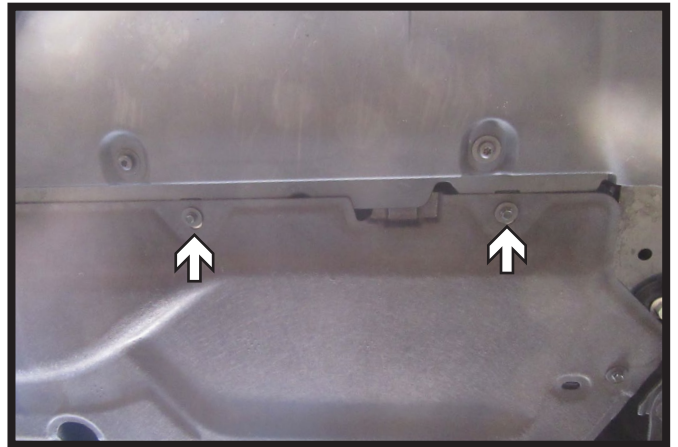
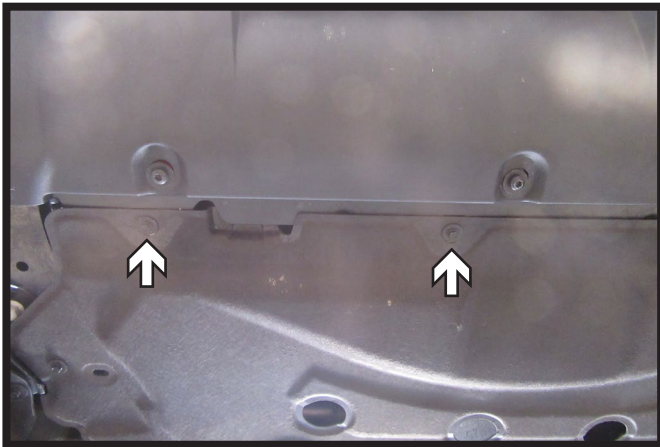

6. Using a 7MM socket, remove the four (4) bolts from the underside of the fascia.

BX2694

2023-2025 Ford Escape Hybrid (No Plug-In) (Includes ACC & Shutters) Installation Instructions

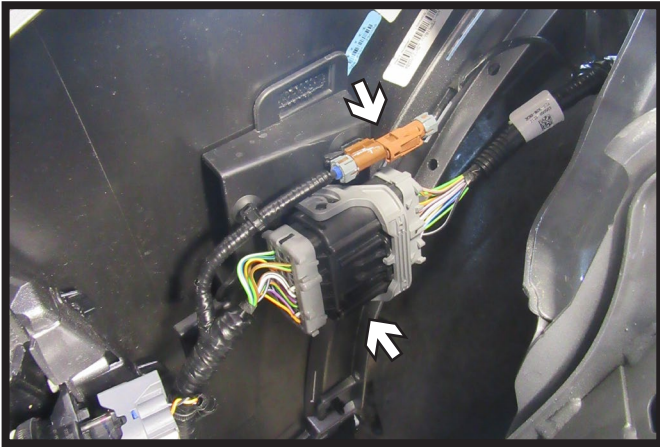

7. Disconnect the two (2) electrical connections on the passenger side of the vehicle. Remove fascia and set aside to be reinstalled later.

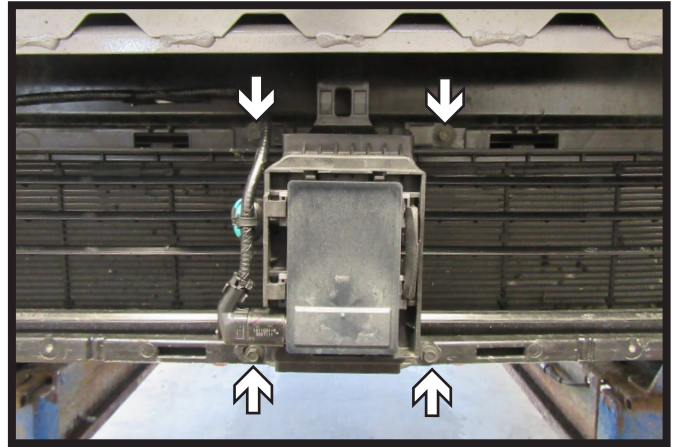

8. Using an 8MM socket, remove the four (4) bolts attaching the Adaptive Cruise Control (ACC) to the vehicle. Let hang out of the way for baseplate installation but DO NOT unplug sensor.

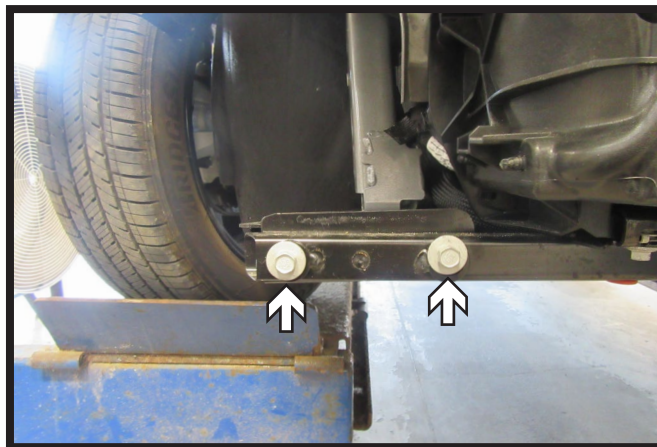

9. Using a 13MM socket, remove the two (2) bolts from the cross bar. Do this on both sides of the vehicle.

BX2694

2023-2025 Ford Escape Hybrid (No Plug-In) (Includes ACC & Shutters) Installation Instructions

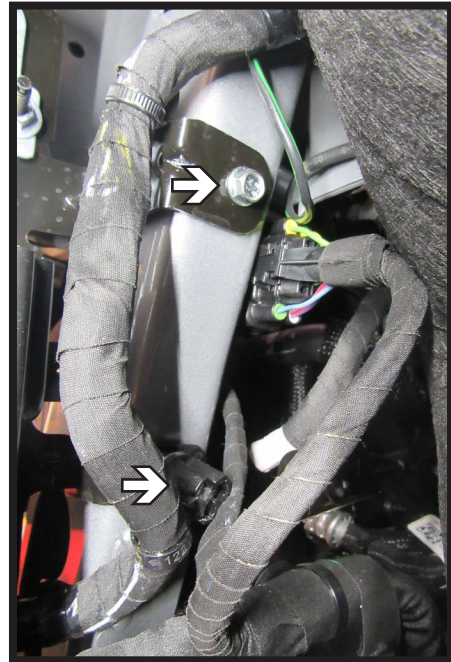
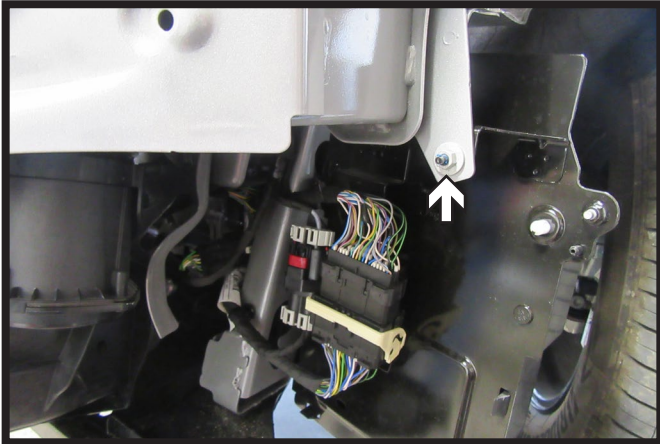

10. Using a 10MM socket, remove the one (1) bolt from the top of the black box in front of the wheel on the driver side of the vehicle (left). Then remove the wire loom from the backside bottom bolt. Using a 10MM deep socket, remove the two (2) bolts from the backside (right). Let box hang out of the way for baseplate installation.

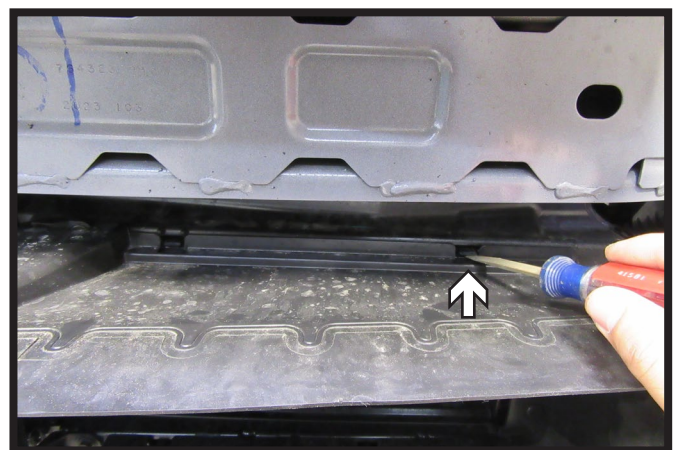
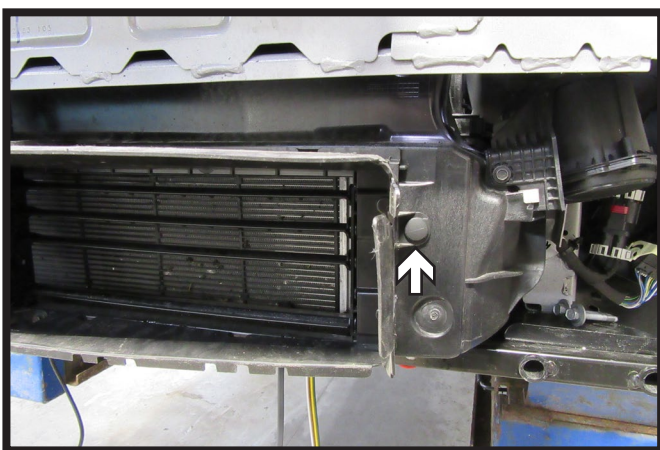

11. Remove the shroud around the lower shutters by removing the two (2) push pins, one (1) on each side of the vehicle. Then using a flat screw driver, remove the eight (8) clips around the edge of the shroud. The shroud will not be reinstalled.

BX2694

2023-2025 Ford Escape Hybrid (No Plug-In) (Includes ACC & Shutters) Installation Instructions

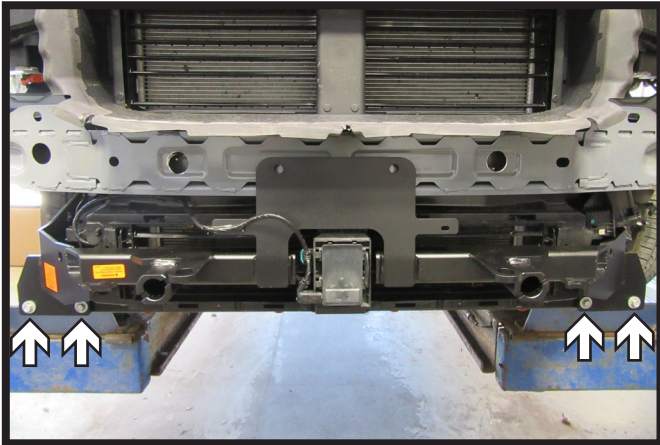

12. Slide the baseplate onto the vehicle and reinstall the four (4) existing 8MM bolts and washers, two (2) on each side. Use level to ensure baseplate is level before tightening bolts.

Note: May need to slightly rotate the pedestrian alert speaker on the driver side of the vehicle to allow for baseplate clearance.

**** Use Loctite® Red on all bolt threads and tighten all bolts to the appropriate torque. ****

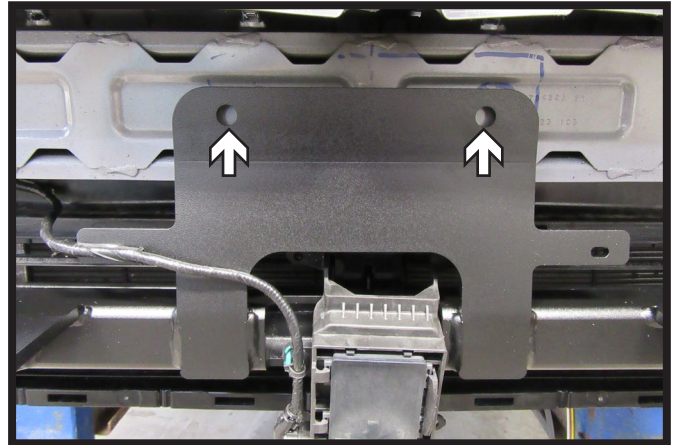

13. Using a 1/2" drill bit, drill out the two (2) holes as shown using the baseplate as a template.

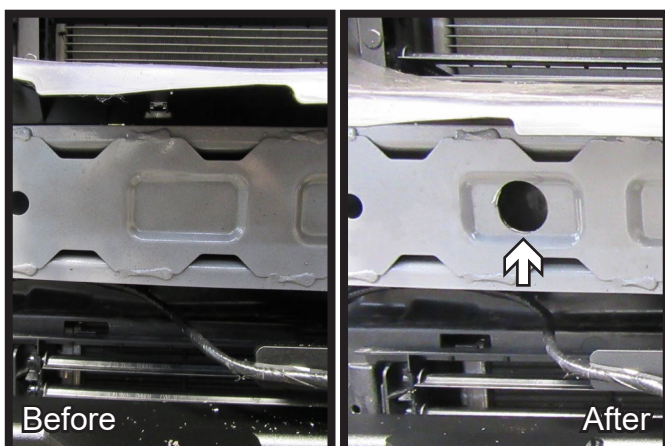

14. Using a 1-1/4" hole saw, drill out the hole as shown to create access hole. Do this on both sides of the vehicle.

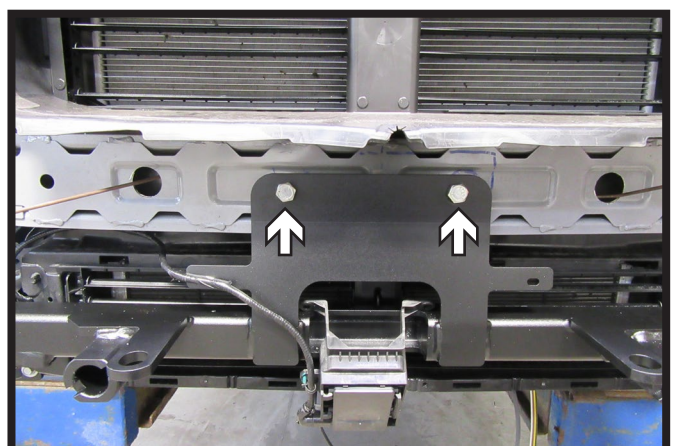

15. Install two (2) 1/2" bolts with washers and wire nuts. Torque bolts to 50 ft/lbs.

**** Use Loctite® Red on all bolt threads and tighten all bolts to the appropriate torque. ****

BX2694

2023-2025 Ford Escape Hybrid (No Plug-In) (Includes ACC & Shutters) Installation Instructions

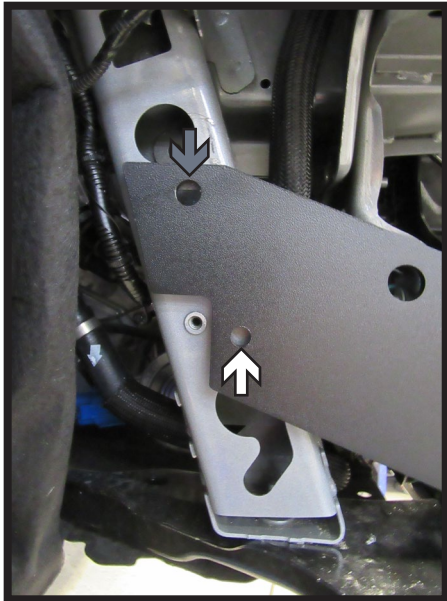

16. Using a 3/8" drill bit, drill out the back bottom hole (white) using the baseplate as a template. If needed use a 1/2" drill bit, drill out the back top hole (gray). Do this on both sides of the vehicle.

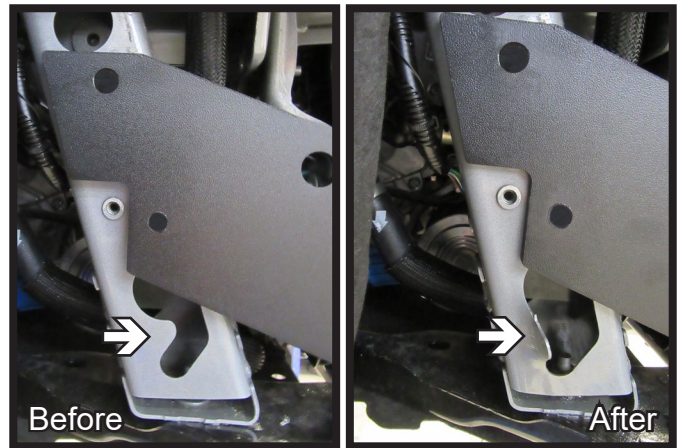

17. Using a pair of large vise grips bend back the frame piece as shown to create an access hole for the nut plate. Do this on both sides of the vehicle.



18. Insert nut plate through hole in the frame. Insert a 1/2" bolt with lock washer into the top hole (white) and a 3/8" bolt with lock washer into the bottom hole (gray). Do this on both sides of the vehicle.

**** Use Loctite® Red on all bolt threads and tighten all bolts to the appropriate torque. ****

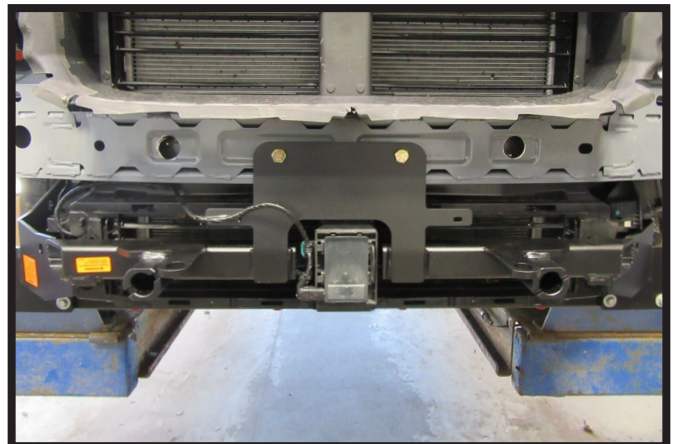

19. Reinstall the four (4) bolts attaching the ACC to the frame.

BX2694

2023-2025 Ford Escape Hybrid (No Plug-In) (Includes ACC & Shutters) Installation Instructions

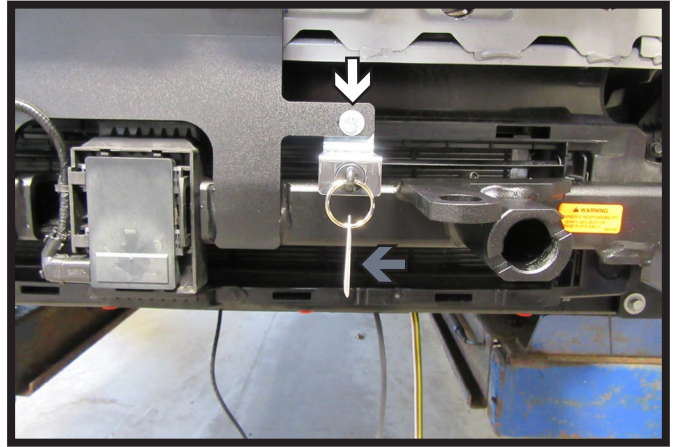
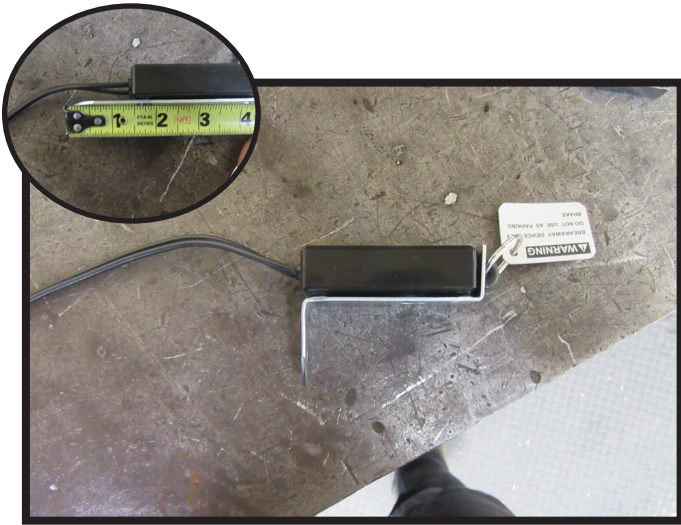

20. **Optional Breakaway:** Put a 90° bend in the breakaway bracket, 1-1/2" from the back and attach to the back of the electrical mounting bracket with provided 1/4" bolt, washers, and nut as shown. Remove white tag (gray) from breakaway switch so it does not interfere with any of the vehicle sensors.

Note: The breakaway bracket should be as parallel to the baseplate and convenience links as possible.

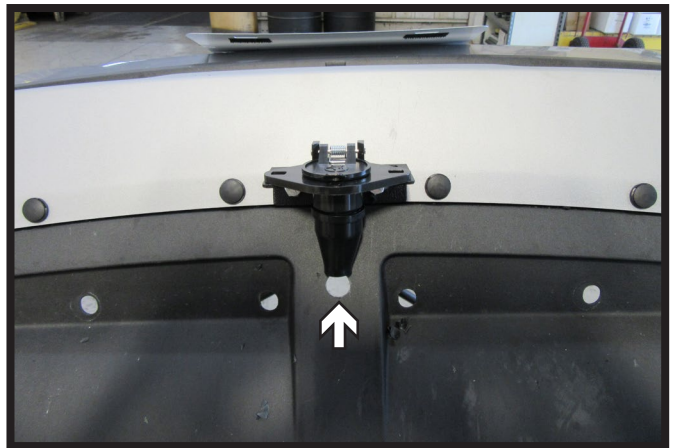

21. Center electrical bracket on bottom of the fascia. Using a 1/4" drill bit, drill two (2) holes using the bracket as a template. Install provided two (2) 1/4" bolts with hardware (left). Hold electrical plug in place and mark fascia below end of plug. Using a 5/8" drill bit, drill one (1) hole to feed tail light electrical wires through (right).

2023-2025 Ford Escape Hybrid (No Plug-In) (Includes ACC & Shutters)
Installation Instructions



22. Attach the permanent baseplate safety cables to the provided convenience link on the baseplate. The photo above shows the recommended installation of the cables to frame of vehicle. Additional options may interfere with suggested mounting; in this case, secure the cables to a solid piece of the frame as described in the General Information sheet. Be sure the safety cables do not rub against any hoses or moving parts. Do this on **BOTH** sides of the vehicle.

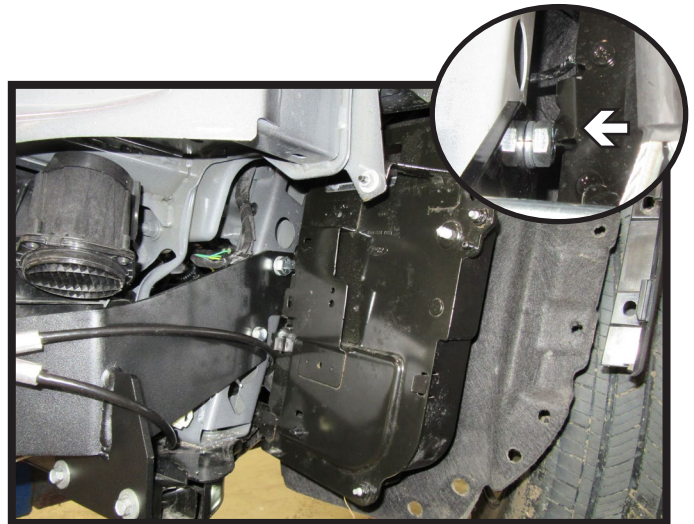

23. Reinstall the black box onto the driver side of the vehicle. Reattach the wire loom to the bottom bolt on the backside. If the box touches the baseplate bolt head, bend back plate slightly to create clearance (inset).

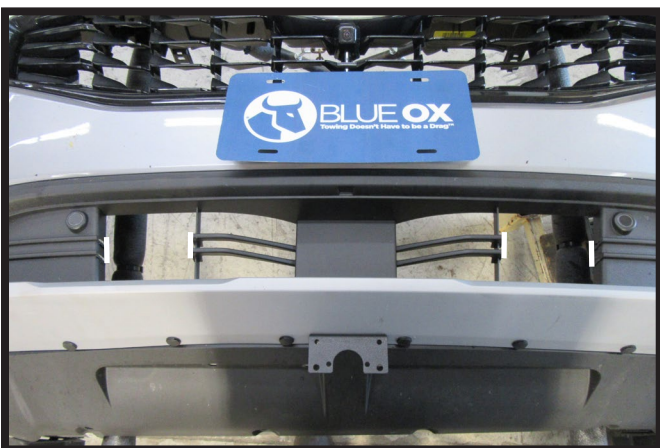

24. Remove the two (2) horizontal slats between the white marks as shown to allow room for the removable tabs and convenience links.



25. Reinstall the fascia and reconnect all electrical connections.
Note: After baseplate installation is complete and during reinstallation of the fascia, there may be limited clearance between the baseplate and the fascia.

BX2694

2023-2025 Ford Escape Hybrid (No Plug-In) (Includes ACC & Shutters)
Installation Instructions

CUSTOMER SERVICE COMMITMENT

Blue Ox® is committed to providing you with exceptional customer care throughout your lifetime with our products. Our team is here to assist you with any questions you may have regarding the performance of your product. Simply call (402) 385-3051 and you can speak with our customer service team.

Additionally, please visit our website to see which rallies our team will be attending. For a nominal fee, our service technician will service your towing system to ensure it's in proper working condition. Also, as a commitment to our customers, should you visit our factory, you can stay at our full service Blue Ox® campground at no charge along with enjoying a factory tour.

Again, thank you for being our customer and for the confidence you have shown in the performance of our products. It is because of customers like you we enjoy the success we have today.



© 2023 Blue Ox
One Mill Road, Industrial Park
Pender, Nebraska 68047
Phone: (402) 385-3051
Fax: (402) 385-3360
www.blueox.com

General Information

1. Ensure that your product(s) are registered online at www.blueox.com. It is crucial to register your product(s) so that you may be alerted of product offerings, updates, upgrades, maintenance and safety bulletins, and/or recalls.
2. **It is the owner's responsibility to inspect all towing equipment for cracked welds, missing or worn parts and loose bolts before each towing trip.** Be sure to use Loctite® Red on all bolts and tighten to the recommended specifications.
3. **It is the owner's responsibility to hook up all towing equipment per manufacturer's instructions/recommendations.**
4. Remove the attachment tabs when not in use (if applicable).

Notice To Baseplate Installer

1. It is YOUR responsibility to watch for:

- Oil cooler and air conditioner lines
- Electrical wires and hoses
- Missing parts or attaching points on the frame

** If the baseplate is improperly installed and is against a wire or hose, it could cause fluid leaks or electrical shorts some time after the actual baseplate installation.

Permanent Baseplate Safety Cable Installation

Permanent baseplate safety cables are strongly recommended when towing a vehicle with a tow bar. The principle function of the permanent baseplate safety cables is to prevent the towed vehicle from breaking loose in the event the connection between the frame of the towed vehicle and the baseplate fails or becomes disconnected. The cables must be connected from the baseplate to the frame rail or cross member of the vehicle's frame. The illustrations below show the possible arrangements recommended by Blue Ox®. Each permanent baseplate safety cable must have an adequate weight rating for the towing system. The weight rating of the two (2) cables together will not qualify.

Do not mount the permanent baseplate safety cables against wires, hoses or brake lines.

These permanent baseplate safety cables should remain installed as long as the baseplate is installed on the vehicle. Permanent baseplate safety cables are to be used in conjunction with, and NOT a replacement for legally required safety cables attaching the towed vehicle to the towing vehicle.

Option #1

(Baseplates with Convenience Link Tabs)

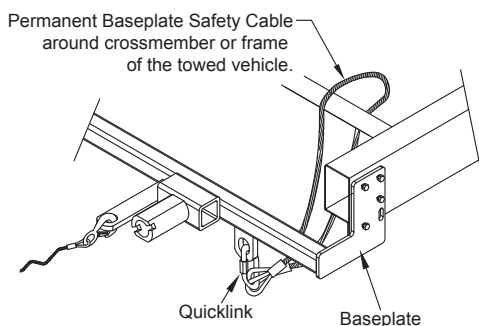

Option #2

(Baseplates with out Convenience Link Tabs)



BLUE OX ORIGINAL PURCHASERS THREE YEAR LIMITED WARRANTY

Automatic Equipment Manufacturing Company ("Automatic") warrants to the original (first) retail purchaser that this product, manufactured by Automatic, shall be free from defect in material and workmanship under normal use and service for a period of three years from the date of delivery.

During said three-year period, Automatic will repair or replace any parts that have been returned by the original purchaser, to the factory, transportation prepaid, and in Automatic's sole and absolute opinion found to be defective.

Limitations on Warranty Coverage:

Coverage under this warranty will be valid only if the customer warranty card is returned by the original purchaser within 30 days of purchase.

Coverage under this warranty will be effective only when a copy of the original invoice, showing date and place of purchase, accompanies any claim for warranty. This warranty is NON TRANSFERABLE.

This limited warranty will not cover, in any way or form, any alleged damages caused by incorrect or improper installation, improper use, modification or neglect of product, failure to properly service and maintain, misuse, act of God, accident or failure of the user to follow guidelines contained in the instructional material provided by Automatic.

This warranty does not cover normal wear and tear, paint or rust.

Warrantor assumes no responsibility to the owner for loss of use of product, loss of time, inconvenience or any other damage consequential or otherwise. Including, but not limited to mileage, expense of transporting of product, return shipping expense, mechanics travel time, telephone, road service, towing, and rental during repairs, travel, lodging, loss or damage to personal property or loss of earnings.

REPAIR OR REPLACEMENT AS SET FORTH IN THIS LIMITED WARRANTY IS THE SOLE EXCLUSIVE REMEDY OF THE PURCHASER. AUTOMATIC SHALL NOT BE LIABLE FOR ANY INCIDENTAL OR CONSEQUENTIAL DAMAGES FOR BREACH OF ANY EXPRESS OR IMPLIED WARRANTY ON THIS PRODUCT. EXCEPT TO THE EXTENT PROHIBITED BY APPLICABLE LAW, ANY IMPLIED WARRANTY OF MERCHANTABILITY OR FITNESS FOR A PARTICULAR PURPOSE ON THIS PRODUCT IS LIMITED IN LENGTH TO THE DURATION OF THIS WARRANTY.

Please visit <http://blueox.com/warranty/> to register your warranty



BLUE OX